

EASTERN

Powered by EcoBurner

Creating **premium buffets** using **sustainable technologies**



2023 Catalogue

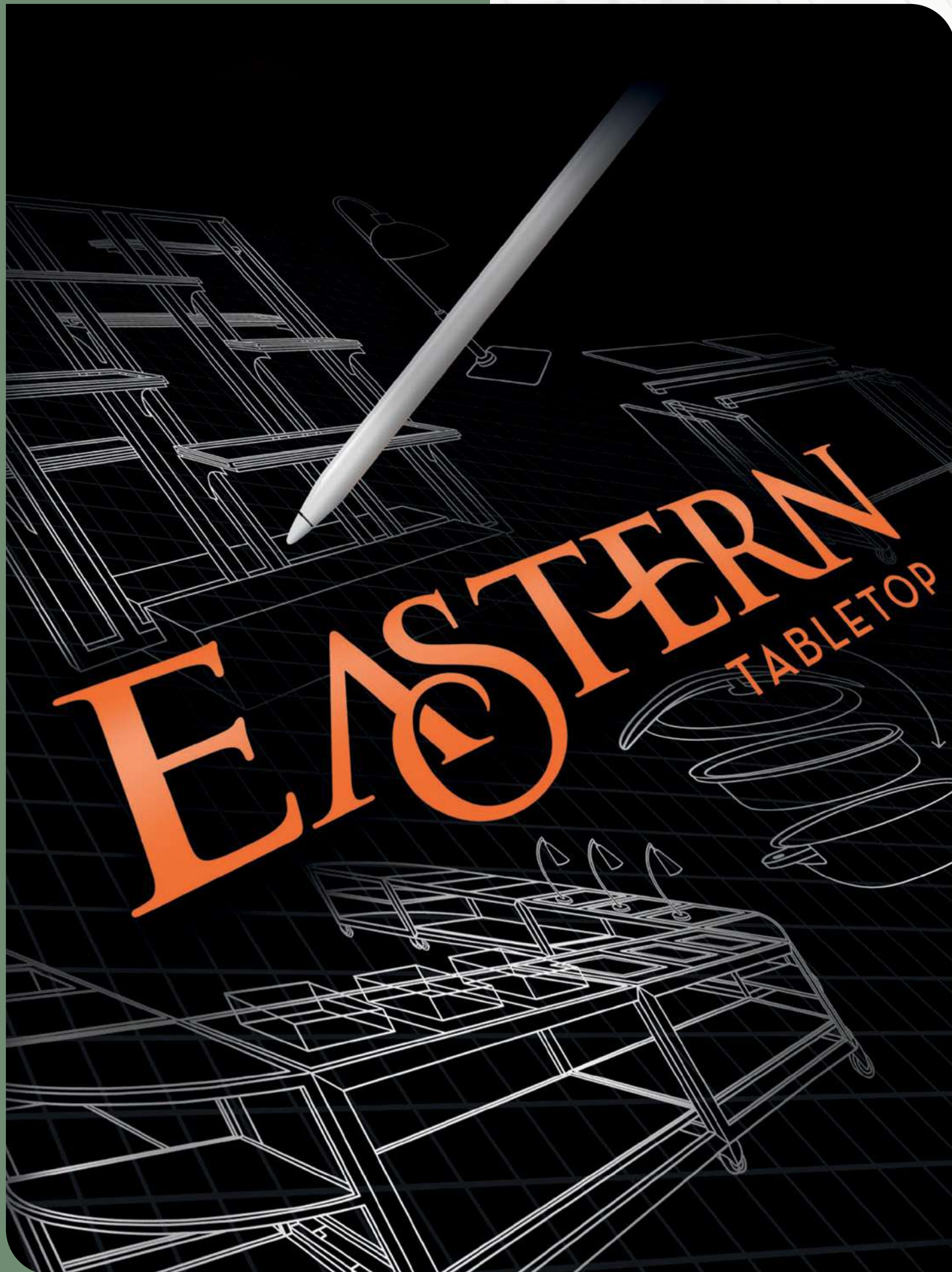

Eastern Tabletop have been known for supplying high quality products to the hospitality industry in the US for over 70 years. In this time, they have always been moving forward to offer their customers the most innovative buffet equipment. This had led to their most recent partnership with EcoBurner.

Although new to some US hotels, EcoBurner have been influencing changes to buffets around the world. Their premium product range gives venues serving buffet the opportunity to reduce their impact on our precious environment. EcoServe and EcoPan, powered by EcoBurner, eliminates the need for water at buffets, reduces carbon emissions by up to 75% and provides an alternative to single-use products like gels and wicks.

Eastern Tabletop chafing dishes can now be 'Powered by EcoBurner' to avail of these environmental benefits and ensure their buffets are sustainable into the future.



You can now choose to

Go GREEN with

EASTERN

Powered by **EcoBurner**

EASTERN

Powered by EcoBurner



Table of Contents

Buffets Powered by EcoBurner	6
Waterless HUB & ZOZZ warming tiles	10
Waterless Roll-Top Chafers	16
Waterless EcoPan	18
EcoServe – Waterless Chafing Dishes	20
Benefits of EcoServe	22
EcoServe GN	24
EcoServe Round	28
Cool Packs for Cold Service	32
EcoServe GN Food Pans	34
Single-Serve Dishes	36
EcoServe Round Accessories	38
EcoBoost	40
Coffee Urns	42
Typical Hotel Savings	44
Zero Water	45
Zero Waste	46
Less Carbon	47
Less Staff Hours	48
1000 Solutions to Change the World	50
Product Codes	56

Buffets Powered by EcoBurner

EcoBurner is a refillable burner that is placed under EcoServe, EcoPan or any chafing dish to keep food warm at buffets. Filled with EcoBurner fuel, it replaces single-use gels/wicks that have no place in modern hospitality.

Simply swap single-use gel or wicks for EcoBurner to improve the safety of your staff and the sustainability of your venue.

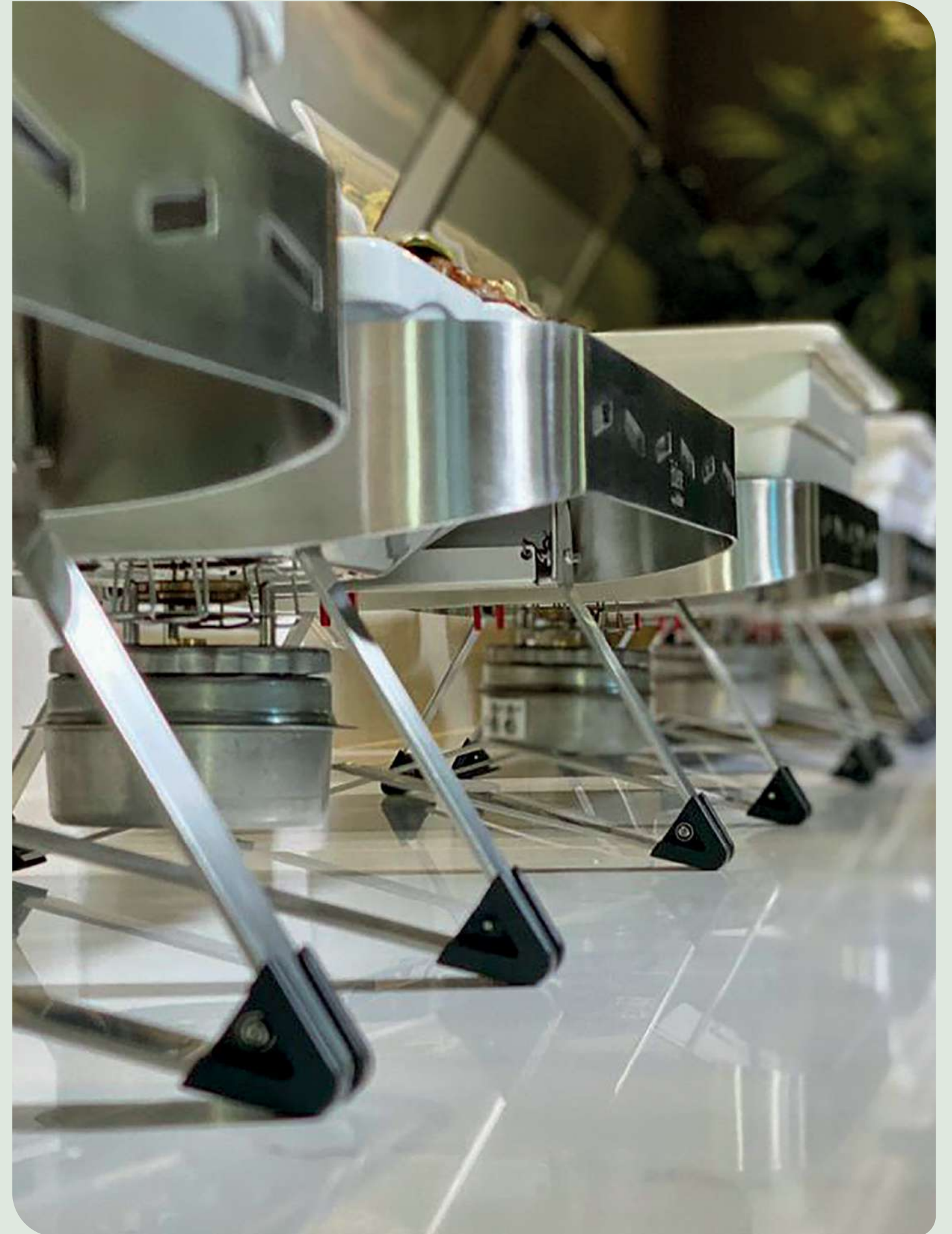

EcoBurner is the SAFER, CLEANER & GREENER alternative to single-use gels and wicks.



✓ Safer

- ✓ Always cool-to-touch.
- ✓ Switches off if overturned or overheated.
- ✓ No open chemicals near food.

✦ Cleaner

- ✓ No black smoky residue left on cookware.
- ✓ No toxic fumes – pleasant atmosphere for guests.
- ✓ No risk of fuel spills.

🌿 Greener

- ✓ Zero fuel waste- all fuel is used or remains safely in the EcoBurner until next service.
- ✓ Zero waste to landfill – EcoBurner is refillable and fuel cans are recyclable creating zero waste.
- ✓ Less carbon – up to 75% less carbon than gels or wicks.



“ EcoBurner Warming Tiles are completely WATERLESS and require NO ELECTRICITY so the HUB or ZOZZ can be easily set up anywhere!



St. Andrews Country Club, Florida

 Suitable for Outdoors

Windproof & Portable



- ✔ No electricity or cables required
- ✔ Warming tiles available to work with HUB & ZOZZ



EcoBurner is fully compatible with the Eastern HUB & ZOZZ systems

Choose a single or twin round or a GN warming tile to fit into the HUB or ZOZZ mobile buffet systems. These can be used with any other combination of tiles available from Eastern to create your ideal mobile buffet station.



Double Round Warming Tile
#EB11803GB



Single Round Warming Tile
#EB1804GB



GN Warming Tile
#EB1807GB

Modular - The EcoServe GN fits into the tile for use on the HUB or ZOZZ



Simply place lighting EcoBurners in the clips provided under the EcoTiles to create a truly mobile buffet system that requires no electric cables or costly batteries.

EcoTile Accessories

Non-stick aluminium and strengthened porcelain dishes for commercial use are available. These accessories compliment the HUB and ZOZZ systems to give chefs more premium presentation options. See page 32-37 for details.



GN Warming Tile with EcoServe GN, 2.6" Porcelain dish and Reinforced GN Glass Lid (Sold Separately).



Twin Round Warming Tile with Round Aluminium Dishes and Glass Lids. (available separately, see page 36 & 37).



Design your Buffet to your Own Style

The EcoTile warming tiles can be mixed with any other Eastern tile to create your own buffet system according to your needs and style.

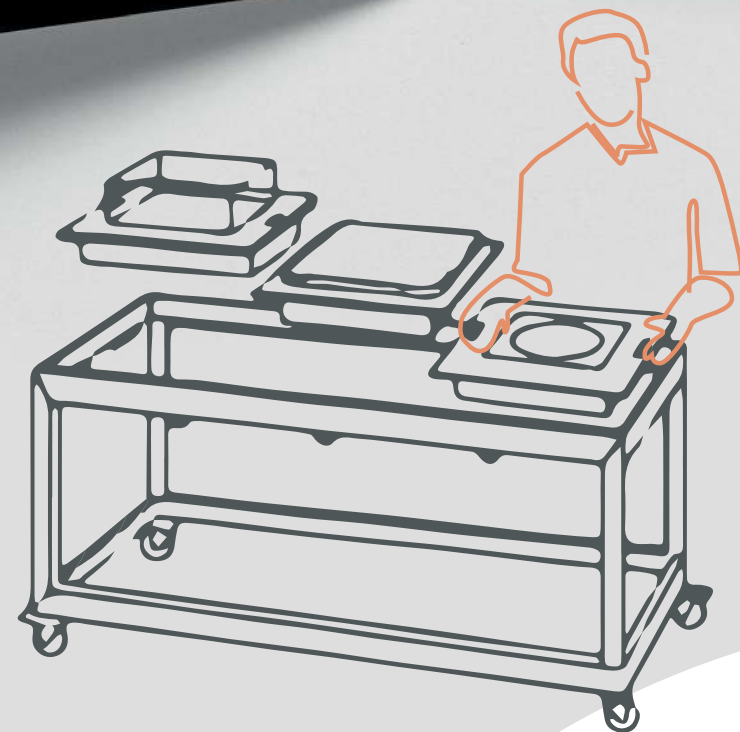

Now you can use Eastern Tabletop chafing dishes, Powered by EcoBurner instead of single-use gels or wicks. The high quality chafing dishes you know and love can now add to your sustainability goals too by reducing carbon and waste. Model numbers 3114, 3124 and 3144 can also be used with EcoPan to completely eliminate the need for water. (See page 20 & 21 for more details).

Go Waterless

Convert rectangle chafers to WATERLESS using the EcoPan. Simply remove the existing water pan and use EcoPan instead. Place an EcoBurner in the clips provided.

5-STAR ROLLTOP CHAFERS

Park Avenue Collection | Rectangular, Round & Square

Convert to Waterless with EcoPan



Place EcoBurner Here



Park Avenue Collection, Rectangle, Stainless Steel 8qt. #3114

Pillard Collection | Rectangular & Round

Convert to Waterless with EcoPan



Place EcoBurner Here



Pillard Collection, Rectangle, Stainless Steel 8qt. #3124

P2 Collection | Rectangular & Round

Convert to Waterless with EcoPan



Place EcoBurner Here



P2 Collection, Rectangle, Stainless Steel 8qt. #3144

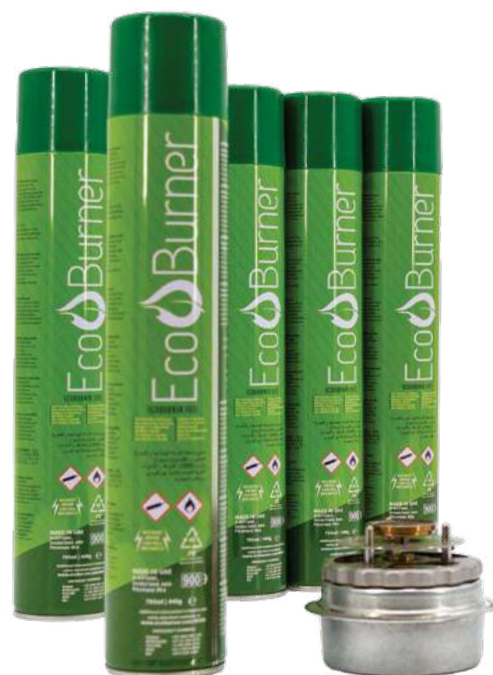

XYLO

Items are available in a variety of finishes, brushed or powder color. Visit www.EasternTableTop.com for full product details.

EcoPan

Go waterless with EcoPan and convert your existing chafer to the EcoBurner system.

If you're happy with your current buffet style and don't want to change your equipment, use EcoPan with your existing chafers to change to a waterless system. Simply swap the waterpan for EcoPan in any GN sized chafing dish and enjoy all the benefits of EcoServe:

-  **Waterless**
-  **Quick & Safe**
-  **Portable & Windproof**
-  **Flexible/Modular**



Each EcoPan saves 581 (US) Gallons of water every year if used instead of a waterpan.



EcoPan
#EB15330



Use two EcoBurners outdoors



Only one EcoBurner is needed for indoor buffet set-ups.



1. Use your existing food pan
2. Drop in NEW EcoPan
3. Combined with your existing chafer

EcoServe – The Waterless Chafing Dish Range



Benefits of EcoServe

Waterless

- ✓ No more filling, heating or wasting water.
- ✓ Better quality food as no steam or condensation from water pans.
- ✓ Saves water – one of earth's most precious resources.

Portable & Windproof

- ✓ Fully portable so buffet can be set up in any location indoors or outdoors.
- ✓ No electricity needed so no dangerous cables lying around.
- ✓ Ideal for outdoor dining as EcoBurner is windproof and can be set up anywhere.



Quick & Safe

- ✓ Heats up in less than 10 minutes.
- ✓ Simple, safer and slicker process for swapping out food dishes.
- ✓ No electricity or cables needed.

Flexible/Modular

- ✓ Buffet can be designed according to style or occupancy levels. Using more or less EcoServe units means that large scale resorts or small corporate events are all catered for with EcoServe.
- ✓ Hot or Cold options available – simply use an EcoServe Cool Pack to switch to cold service.

EcoServe GN

Designed to fit in with the architecture of commercial kitchens around the world.

Filling chafing dishes with water is both time-consuming and wasteful which doesn't suit the agenda of modern hotels seeking sustainable systems.

EcoServe is a waterless replacement to chafing dishes that is quick and easy to set up in any location which gives venues huge flexibility to create their own buffets according to location preference, style and occupancy levels.

Commercial kitchens around the world are often built around the standard GN sizing. EcoServe GN suits this universal size and will work well with any GN sized dishes giving chefs seeking premium presentations a more modern look.



EcoBurner as a heat source



Cool Pack for cold service



St. Andrews Country Club, Florida



The legs are easily folded in for space-saving storage. EcoServe GN measures 20" x 12" x 3" (LxWxH) when legs are folded.

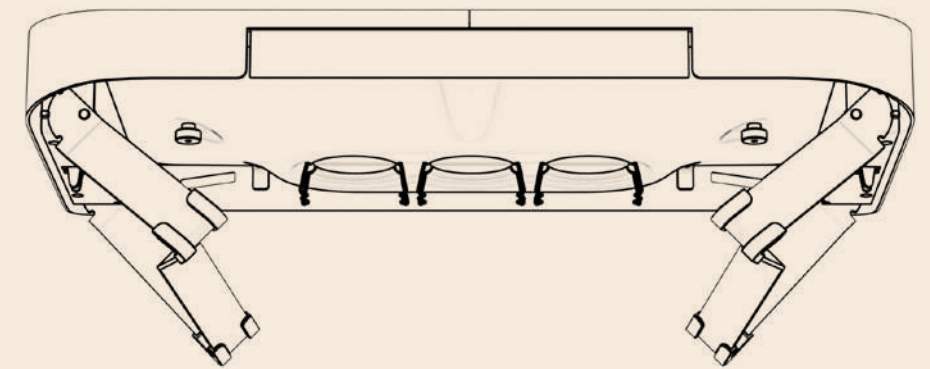

Space-saving Storage

Space is often at a premium when it comes to storing buffet equipment, so we've designed the EcoServe GN with folding legs. This allows them to be stacked neatly for easy space-saving storage when not in use.

When stored away, 6 EcoServe GN's take up less space than 1 traditional chafing dish





Canonniers Beachcomber,
Mauritius

EcoServe GN is available to order in six colours

Buffet food deserves to be presented in the most elegant way and the EcoServe GN gives chefs this opportunity to showcase their creations for maximum impact.

It's innovative style and shape is unique; guests can see exactly what is available and chefs have complete autonomy to change the look of the buffet according to their own style.

Available in six colours with an option to add a reinforced glass lid which includes a soft close hinge that can be adjusted according to the height of the dish being used. It features an intelligent condensation recirculating system whereby any condensate is quickly captured, returned to the heat source and evaporated before build-up, giving guests a clear view of the delicious food on offer.



Scan QR code for product information on the EcoServe GN



Powder-coated Black
#EB15320



Gold PVD
#EB15317



Polished Stainless Steel
#EB15316



Rose Gold PVD
#EB15318



Brushed Stainless Steel
#EB15314



Powder-coated White
#EB15313



Scan QR code for product information on the reinforced glass lid #EB15311



EcoServe Round

To cater for differing styles and occasions, EcoServe is also available as a round unit.

Both large and small designs are available in the same six finishes as EcoServe GN. This compliments the GN range so that chefs can design the buffet using different configurations in varying locations to create unique and memorable guest experiences.



- Powder-coated Black | sm #EB15004 | lrg #EB15005
- Powder-coated White | sm #EB15006 | lrg #EB15007
- Brushed Stainless Steel | sm #EB15008 | lrg #EB15009
- Polished Stainless Steel | sm #EB15016 | lrg #EB15015
- PVD Gold | sm #EB15013 | lrg #EB15014
- PVD Rose Gold | sm #EB15011 | lrg #EB15012

“

EcoServe Round features all the benefits of the GN but increases the choice for chefs to use different shapes and sizes to create unique and memorable guest experiences.

Taj Land's End, Mumbai





EcoServe Accessories

EcoServe Cool Packs

Simply freeze the EcoServe Cool Pack overnight and use it instead of an EcoBurner to switch to cold service.



EcoServe GN Cool Pack
#EB15322

“ Ideal for seafood, salads, fruit and desserts!



EcoServe Round Large Cool Pack
#EB15305



Castletoy Park Hotel, Ireland



Solana Beach, Mauritius

EcoServe Accessories

EcoServe GN Food Pans for HOT or COLD service

EcoBurner offer a selection of carefully chosen food pans to compliment the EcoServe GN look. The commercial-use porcelain dishes are available in a deep option, a platter and a divided dish for smaller portions.

The black non-stick aluminium dish offers chefs a more robust option that boasts exceptional durability and resistance to abrasion. All food pans can go directly from oven to buffet display ensuring the presentation is kept to a premium.

If dishes are being used for cold service, it is advised to chill the dishes prior to display to prolong the buffet presentation.



Premium Non-Stick Aluminium Dish - GN 1/1
#EB15315



2.6" Deep Porcelain Dish - GN 1/1
#EB15400



0.8" Shallow Porcelain Dish - GN 1/1
#EB15209



Divided Porcelain Dish - GN 1/1
#EB15401

EcoServe Accessories

Single-Serve GN options for HOT or COLD display

The grab-n-go concept is here to stay. Offering individual portions at the buffet means the first guest experiences exactly the same as the last guest. Chef can dress each portion and presentation is kept consistent throughout service.

Serving individual portions not only minimises guests handling food, but also encourages guests to bring less food to their table, creating less food waste. Another step on the road to sustainable hospitality!



“ Single-serve dishes offer uniform presentation from the first guest to the last no matter when they attend the buffet.



Portion Control

Different size dishes allow for different amounts of food such as 8oz rice or 2oz salmon. Guests are less likely to over-indulge as they'll usually pick up single individual portions leading to less food waste overall.

Fresher Food

Dishes can be replenished on a first-in, first-out basis meaning no more food left in corners of dishes for too long.

No Cross-Contamination

No shared utensils reduces cross-contamination and guests can be confident that no one else has touched their food.

Single-serve dish and lid - large (6 per EcoServe GN)

Lid #EB15328
Dish # EB15325



Single-serve dish and lid - square (8 per EcoServe GN)

Lid # EB15329
Dish #EB15326



Single-serve dish and lid - small (12 per EcoServe GN)

Lid #EB15327
Dish #EB15324



Scan QR code for product information



EcoServe Accessories

EcoServe Round Accessories for HOT or COLD display

Premium Non-Stick Aluminium Dishes

These premium non-stick aluminium dishes create a sleek look at any buffet. They boast the most robust coating available worldwide and are engineered to outlast other internally reinforced coatings. These premium dishes are designed to dock securely into the EcoServe Rounds and are built to withstand commercial use in the busiest of kitchens. Available in large and small in both colours, Black Moonscape and Arctic Grey.



Premium Non-Stick
Aluminium Dishes

- Black Moonscape | Lrg # EB15218 | Sm #EB15219
- Arctic Grey | Lrg # EB15210 | Sm # EB15211



Round Glass Lids:
Large # EB15302
Small # EB15301



Pot Lid/ Spoon Rack
EB15300

Glass lids

Glass lids are available in small and large to ensure food stays hot at the buffet while guests can still view what delicious food is on offer.

Pot Lid/ Spoon Rack

A convenient Pot Lid/ Spoon Rack is also available to provide guests with a place to rest lids and spoons used at the buffet.



Boost the efficiency of EcoBurner if not using EcoPan

EcoBoost Max

To maximise fuel efficiency, we recommend using the EcoBoost MAX. Simply attach an EcoBoost bracket to the bottom of any chafing dish so that it brings the EcoBurner closer to the dish and creates a windproof heat chamber that disperses the heat more effectively. EcoBoost reduces the amount of fuel needed to keep food warm and enhances the wind proofing benefits so is ideal for outdoor use in any catering situation.



EcoBoost MAX
#EB11133

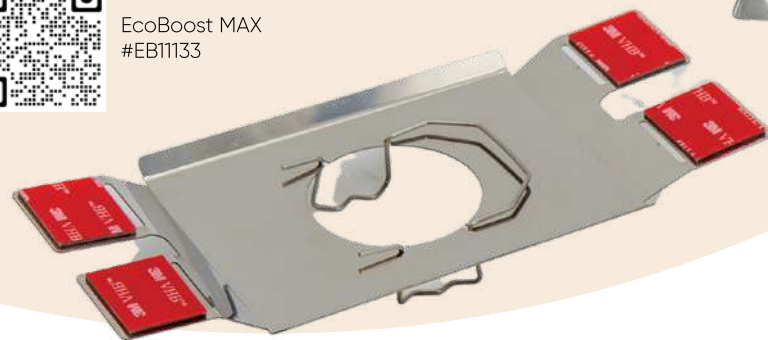

“ EcoBoost reduces the amount of fuel needed to keep food warm and enhances the wind proofing benefits so is ideal for outdoor use in any catering situation.

EcoBoost MINI

Some hotels simply can't attach the EcoBoost MAX to their chafing dishes so the MINI will do as an alternative in these cases, but we do recommend using EcoBoost MAX as it will be more efficient.

The EcoBoost MINI clips onto the top of the EcoBurner to prevent heat being deflected back onto the EcoBurner to improve efficiency and is an easy way to start using the EcoBurner under any chafing dish.



EcoBoost Mini
#EB11139

Use EcoBoost to convert Eastern Rolltop Chafers to EcoBurner



Place EcoBurner Here

Park Avenue Collection, Square Stainless Steel 4qt. #3117



Place EcoBurner Here

Park Avenue Collection, Round Stainless Steel 8qt. #3118



Place EcoBurner Here

Park Avenue Collection, Round Stainless Steel 4qt. #3119



Place EcoBurner Here

Pillard Collection, Round, Stainless Steel 4qt. #3128



Place EcoBurner Here

P2 Collection, Round Stainless Steel 8qt. #3148



“ Safe and Sustainable Buffets



EcoBurner #EB18999

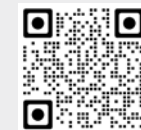

EcoBurner Fuel #EB19009

Coffee Urns



4-Star Ballerina Collection | Coffee Urns 5, 3 & 1.5 Gallon



EcoBoost MINI is required for efficient heating of coffee urns

5-Star Jazz Rock Collection | Coffee Urns 5 & 3 Gallon



4-Star | Coffee Urns 5 & 3 Gallon

COLLECTION

MODEL#

BALLERINA

5 Gallon
Stainless Steel

#3135

3 Gallon
Stainless Steel

#3133

1.5 Gallon
Stainless Steel

#3131



JAZZ ROCK

5 Gallon
Stainless Steel

#3285

3 Gallon
Stainless Steel

#3283



4-STAR MODELS

A. Park Avenue- 5Gal.
Stainless Steel

#3115



A. Park Avenue- 3Gal.
Stainless Steel

#3113



B. Pillar'd - 5 Gal.
Stainless Steel

#3125



B. Pillar'd - 3Gal.
Stainless Steel

#3123



C. P2 - 5 Gal.
Stainless Steel

#3145



C. P2 - 3Gal.
Stainless Steel

#3143



Coffee Urns

EcoBurner provides adjustable heat for coffee

Piping hot coffee for up to 7 hours

No electricity required

Portable - bring your coffee anywhere it's needed

Demonstrate your environmental savings to your guests



Powered by **EcoBurner**

XYLO

Items are available in a variety of finishes, brushed or powder color. Visit www.EasternTableTop.com for full product details.

Savings

When hotels and banqueting facilities switch to the EcoBurner system instead of gels or wicks, there are numerous savings to be made but the savings in **WATER, WASTE, CARBON** and **STAFF HOURS** are especially significant.

We've taken an example of a hotel using 20 chafing dishes, twice a day, for 3 hours each service, and calculated what savings that hotel would make if they switched to EcoBurner.

TYPICAL SAVINGS OVER A YEAR

Key Assumptions for calculations



WATER
11,600 gallons (US)



WASTE
1.72 US Tons



CARBON
6.6 US Tons



STAFF HOURS
1,947 hrs.



Student Hotel, Amsterdam



Zero Water

By eliminating the need for water at the buffet, hotels benefit from:

- ✓ Reduced WATER usage.
- ✓ Reduced risk of injury from handling water.
- ✓ Reduced staff hours handling water.
- ✓ Reduced energy usage from not having to heat up water.

TYPICAL HOTEL SAVING

Key Assumptions for calculations



Each traditional chafing dish uses approximately 0.265 US Gal of water for every hour of use. If in use for 3 hours, twice a day, that's 1.59 gal (US) per day.

Multiply by 365 days a year
=580 gal (US)

Multiply by 20 chafing dishes
=11,600 gal (US)

X

X



11,600 Gal (US) water saved annually



Tamassa, Mauritius

Zero Waste

By switching to EcoBurner, hotels can reduce waste in a number of ways:

- ✓ Reduced fuel waste – every drop of EcoBurner fuel is used unlike gels/wicks that are generally disposed of with left-over fuel remaining at the end of every service.
- ✓ Reduced packaging waste – Each can of EcoBurner fuel is the equivalent of 18 cans of gels/wicks.
- ✓ Recyclable packaging – EcoBurner fuel cans are fully recyclable!

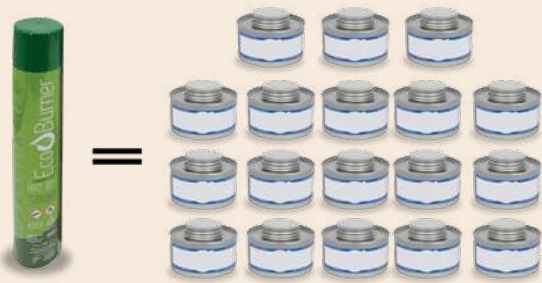

1 EcoBurner Fuel Can
= 18 (2-hour) gel pots

TYPICAL HOTEL SAVING

Key Assumptions for calculations



6hrs per day x20 chafing dishes = 120 hrs per day = 43,800 hrs. per year	Divide by 0.7 (Typically there is 30% gel/wick fuel wasted after every service) = 62,571 hrs. per year	Divide by 2 (2-hour gel) = 31,286 gel/wick pots used	Multiply by 1.76oz (Each gel pot weighs approx. 1.76oz) = 55,062oz = 1.72 Tons
---	---	---	--



1.72 Tons of waste prevented from going to landfill

Less Carbon

The Carbon savings that EcoBurner users benefits from are certified by an independent body in the UK, Carbon Footprint Ltd. In summary their report highlights the amount of carbon emitted during a typical buffet service of three hours using different heating methods. DEG, Ethanol, Methanol gels/wicks, Induction and EcoBurner are analysed and results are as follows:

Carbon Savings Per Hour as certified by Carbon Footprint Ltd.



Product	Emissions for 8,000 hours based on "3-hour in use" scenario (kg CO2e)
Industry Standard (Ethanol)	1,928
Industry Standard (Methanol)	1,386
Industry Standard (DEG)	1,243
Induction Heater	3,864
EcoBurner	423

TYPICAL HOTEL SAVING

Key Assumptions for calculations



6 hrs. per day X 20 chafing dishes = 120 hrs. per day = 43,800 hrs. per year	Multiply by the carbon savings per hour compared to EcoBurner as certified by Carbon Footprint Ltd. 43,800 hrs. X 0.137 (Average carbon savings gels/wicks per hour) = 6,000.6kg, 6,000.6kg = 6.6 US Tons
--	--



6.6 US Tons of Carbon saved annually



EcoBurner Environmental Savings Initiative

Switching to EcoBurner helps save water, waste and carbon so we run a certification programme to recognise these savings. Venues submit the amount of EcoBurner fuel they've used instead of gels and wicks and we calculate their water, waste and carbon savings based on fuel consumption.

Email info@ecoburner.com to submit your fuel usage, we'll verify it and send you your certificate!



Less Staff Hours

When hotels use traditional water-based chafing dishes, staff need to fill the water pans, get the water to temperature and then dispose of the water at the end of service. If they switched to EcoServe or EcoPan, this unnecessary handling of water is eliminated so there is a saving of approximately 8 minutes per chafing dish.



TYPICAL HOTEL SAVING

Key Assumptions for calculations



20 chafing dishes



In use twice a day



For 3 hours each service

8 minutes per chafer X 20 chafing dishes = 160 mins.

Multiply by 2 (twice a day) = 320 mins per day = 116,800 mins per year divided by 60 = 1,947 hours per year

X



1,947 Staff Hours saved annually



Shangri-La's le Touessrok in Mauritius

St. Andrews Country Club, Florida

Member of

WORLD ALLIANCE
for EFFICIENT SOLUTIONS

by **SOLARIMPULSE**
FOUNDATION

EcoBurner has been awarded the "Solar Impulse Efficient Solution" Label, a proof of high standards in profitability and sustainability.

Solar impulse identified 1000+ clean and profitable solutions to address environmental issues without compromising on economic growth and EcoBurner is one of them! This is thanks to the WATER and CARBON savings achieved by using the EcoBurner system instead of gel and wicks.

To receive the "Solar Impulse Efficient Solution" Label, EcoBurner was thoroughly assessed by a pool of independent experts according to 5 criteria covering the three main topics of Feasibility, Environmental and Profitability. All labelled solutions are part of the #1000solutions portfolio that are presented to decision-makers in business and government by Bertrand Piccard, Chairman of the Solar Impulse Foundation. The aim of this initiative is to encourage the adoption of more ambitious environmental targets and fast-track the implementation of these solutions on a large scale.



**WE ARE
PART OF
THE 1000
SOLUTIONS
TO CHANGE
THE
WORLD**

#1000solutions

EASTERN



The HUB & Zozz
warming tiles



Eastern
Coffe Urns



EcoServe
WATERLESS
Chafing Dishes



Eastern Rolltop Chafers

Convert to
WATERLESS
with EcoPan

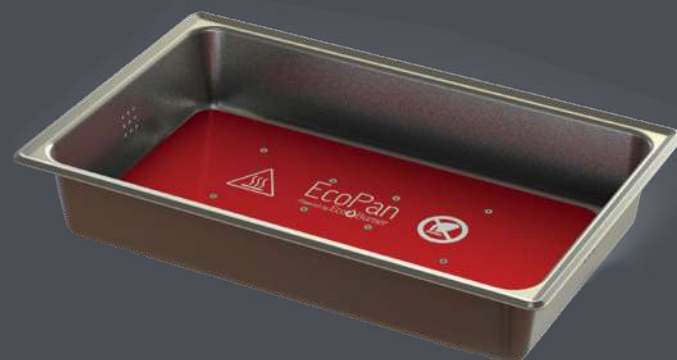

Powered by EcoBurner

“EcoServe looks good anywhere



Newcastle Racecourse & Conference Centre, UK



Solana Beach, Mauritius



St. Andrews Country Club, Florida



The Residence Bintan, Indonesia

Product Codes

Product Category	Product Name	Product Code	Colour	Qty	Unit Length (inch)	Unit Width (inch)	Unit Height (inch)	Unit Weight (lbs)
EcoBurner & Fuel	EcoBurner - ROW - English, French, Spanish, German	EB18999	n/a	1	4.21	4.21	3	0.76
	EcoBurner Fuel - ROW (UAE) - 6 cans	EB19009	n/a	6	2.56	2.56	13.78	1.35
EcoTile	EcoTile Single Round Warming Tile	EB1804GB	Grey grained /black	1	31	22.25	1	20
	EcoTile Double Round Warming Tile	EB11803GB	Grey grained /black	1	31	22.25	1	25
	EcoTile GN Warming Tile	EB1807GB	Grey grained /black	1	31	22.25	1	35
EcoPan	Waterless EcoPan - GN	EB15330	Stainless Steel	5	22	14	5	6.5
EcoServe GN	EcoServe GN - Polished Stainless Steel	EB15316	Polished Stainless Steel	1	20	12	6.30	11.55
	EcoServe GN - Brushed Stainless Steel	EB15314	Brushed Stainless Steel	1	20	12	6.30	11.55
	EcoServe GN - Rose Gold PVD	EB15318	Rose Gold PVD	1	20	12	6.30	11.55
	EcoServe GN - Gold PVD	EB15317	Gold PVD	1	20	12	6.30	11.55
	EcoServe GN - Powder-coated Black	EB15320	Black	1	2	12	6.30	11.55
	EcoServe GN - Powder-coated White	EB15313	White	1	20	12	6.30	11.55
	Toughened Glass Lid - EcoServe GN (Hinge & Fittings included)	EB15311	n/a	1	22	16.30	5.71	7.88
EcoServe Round	EcoServe Round - Polished Stainless Steel - Large	EB15015	Polished Stainless Steel	1	14.37	14.37	7.87	8.03
	EcoServe Round - Brushed Stainless Steel - Large	EB15009	Brushed Stainless Steel	1	14.37	14.37	7.87	8.03
	EcoServe Round - Rose Gold PVD - Large	EB15012	Rose Gold PVD	1	14.37	14.37	7.87	8.03
	EcoServe Round - Gold PVD - Large	EB15014	Gold PVD	1	14.37	14.37	7.87	8.03
	EcoServe Round - Black - Large	EB15005	Black	1	14.37	14.37	7.87	8.03
	EcoServe Round - White - Large	EB15007	White	1	14.37	14.37	7.87	8.03
	EcoServe Round - Polished Stainless Steel - Small	EB15016	Polished Stainless Steel	1	12	12	6.50	5.28
	EcoServe Round - Brushed Stainless Steel - Small	EB15008	Brushed Stainless Steel	1	12	12	6.50	5.28
	EcoServe Round - Rose Gold PVD - Small	EB15011	Rose Gold PVD	1	12	12	6.50	5.28
	EcoServe Round - Gold PVD - Small	EB15013	Gold PVD	1	12	12	6.50	5.28
	EcoServe Round - Black - Small	EB15004	Black	1	12	12	6.50	5.28
	EcoServe Round - White - Small	EB15006	White	1	12	12	6.50	5.28
EcoServe GN Accessories	EcoServe GN Cool Pack	EB15322	White	1	21	12.87	1.30	11.00
EcoServe Round Accessories	EcoServe Round Cool Pack - Large	EB15305	White	1	10.55	10.55	1.57	3.47

Product Codes

Product Category	Product Name	Product Code	Colour	Qty	Unit Length (inch)	Unit Width (inch)	Unit Height (inch)	Unit Weight (lbs)
EcoServe GN Accessories	6.5cm/ 2.6" Deep Porcelain Dish - Gastronorm 1/1	EB15400	White	1	21	12.80	2.87	9.76
	2cm/ 0.8" Shallow Porcelain Dish - Gastronorm 1/1 X 2 Units	EB15209	White	6	21	12.806	1.18	13.09
	Divided Porcelain Dish - Gastronorm 1/1	EB15401	White	1	21	12.80	2.56	9.35
	Premium Non-Stick Aluminium Dish - GN 1/1	EB15315	Black	1	21	12.80	2.44	9
	Single-serve dish - small (12 per EcoServe GN)	EB15324	White	1	4.80	3.50	1.57	0.51
	Single-serve dish - large (6 per EcoServe GN)	EB15325	White	1	6.46	4.61	0.98	0.74
	Single-serve dish - square (8 per EcoServe GN)	EB15326	White	1	4.57	4.57	1.57	0.58
	Lid for single-serve dish - small (12 per EcoServe GN)	EB15327	Transparent Blue	1	5.16	3.90	1.34	0.14
	Lid for single-serve dish - large (6 per EcoServe GN)	EB15328	Transparent Blue	1	6.85	5.04	2.20	0.22
	Lid for single-serve dish - square (8 per EcoServe GN)	EB15329	Transparent Blue	1	4.92	4.92	1.34	0.18
EcoServe Round Accessories	Premium Non-Stick Aluminium Round Dish- Large - Arctic Grey	EB15210	Arctic Grey	1	13.54	13.54	2.76	5
	Premium Non-Stick Aluminium Round Dish - Small - Arctic Grey	EB15211	Arctic Grey	1	11.54	11.54	3.15	4.35
	Premium Non-Stick Aluminium Round Dish- Large - Black Moonscape	EB15218	Black	1	13.54	13.54	2.76	5
	Premium Non-Stick Aluminium Round Dish- Small - Black Moonscape	EB15219	Black	1	11.54	11.54	3.15	4.35
	Glass Lid - Large x 1 (Handle attached)	EB15302	n/a	1	13.78	13.78	2.76	3
	Glass Lid - Small x 1 (Handle attached)	EB15301	n/a	1	11.61	11.61	2.76	2.28
	Pot Lid Spoon Rack	EB15300	Stainless Steel	1	7.48	6.30	8.27	0.65
EcoBoost	EcoBoost MAX - 20 units	EB11133	n/a	20	8.86	3.94	1	0.17
	EcoBoost MINI X 20 units	EB11139	n/a	20	4.13	4.13	0.79	0.08
EcoBurner Accessories	Filling Station	EB19502	n/a	1	7.48	4.53	8.66	2.82
	EcoBurner USB Lighter	EB15307	n/a	1	10.04	1.18	0.79	0.64

Product Codes

Product Category	Product Name	Product Code	Shape	Capacity
5-Star Rolltop Chafers	Park Avenue Collection	3114	Rectangle	8qt.
	Park Avenue Collection	3117	Square	4qt.
	Park Avenue Collection	3118	Round	8qt.
	Park Avenue Collection	3119	Round	4qt.
	Pillard Collection	3124	Rectangle	8qt.
	Pillard Collection	3128	Round	8qt.
	P2 Collection	3144	Rectangle	8qt.
	P2 Collection	3148	Round	8qt.
Coffee Urns	4-star Ballerina Collection	3135		5 gallons
	4-star Ballerina Collection	3133		3 gallons
	4-star Ballerina Collection	3131		1.5 gallons
	4-star Jazz Rock	3285		5 gallons
	4-star Jazz Rock	3283		3 gallons
	4-star	3115		5 gallons
	4-star	3113		3 gallons
	4-star	3125		5 gallons
	4-star	3123		3 gallons
	4-star	3145		5 gallons
	4-star	3143		3 gallons









EASTERN

Powered by EcoBurner

Corporate Headquarters, Showroom & Warehouse:
Eastern Tabletop Manufacturing
Company Inc.
50 Ingham Avenue,
Bayonne NJ 07002.

Telephone: 1-718-240-9595
Toll Free: 1-888-422-4142

Connect with us on social media!

-  www.facebook.com/EcoBurnerInternational
-  www.linkedin.com/company/ecoburner
-  www.instagram.com/ecoburner
-  www.youtube.com/@EcoBurnerBuffets

Visit www.us.ecoburner.com for full product details.



Solana Beach, Mauritius



Creating **premium buffets**
using **sustainable technologies**
| **2023 Catalogue**